

●尺寸图/DIMENSION (单位/UNIT : mm)

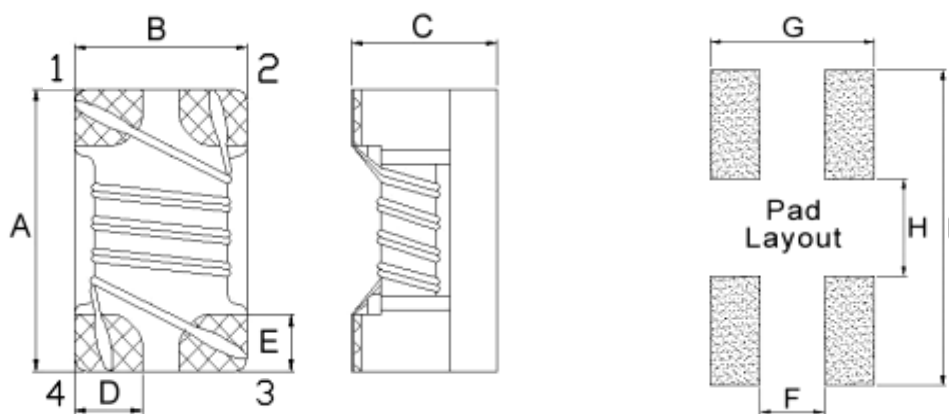

A: 3.2 ± 0.2	B: 2.5 ± 0.2	C: 2.2 ± 0.2	D: 0.9 Typ	E: 0.8 Typ
F: 0.6 Typ	G: 3.5 Typ	H: 1.6 Typ	I: 4.4 Typ	

●电路图/SCHEMATIC

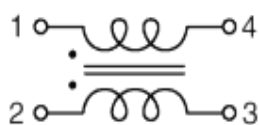

●注意事项/NOTE :

- 1.产品不印字
- 2.崩缺面积直径小于0.3mm为允收

●电气特性/ELECTRICAL CHARACTERISTIC

Part Number	Common mode Impedance (Ω @100MHz)	DC Resistance (Ω) Max.	Rated Current (mA)Max.	Rated Volt. (Vdc)Max.	IR (Ω) min.
GCM-3225SF-900	$90 \pm 25\%$	0.10	1000	50	10M
GCM-3225SF-601	$600 \pm 25\%$	0.20	1000	50	10M
GCM-3225SF-102	$1000 \pm 25\%$	0.30	400	50	10M

- (1).Rated Current: Temp.rise 40°C Typ
- (2).Operating Temperature: -40°C up to $+125^\circ\text{C}$
- (3).Storage Temperature: -20°C up to $+40^\circ\text{C}$, 75% RH max.

● 特征曲线/CHARACTERISTICS(REFERENCE)

GCM-3225SF-900

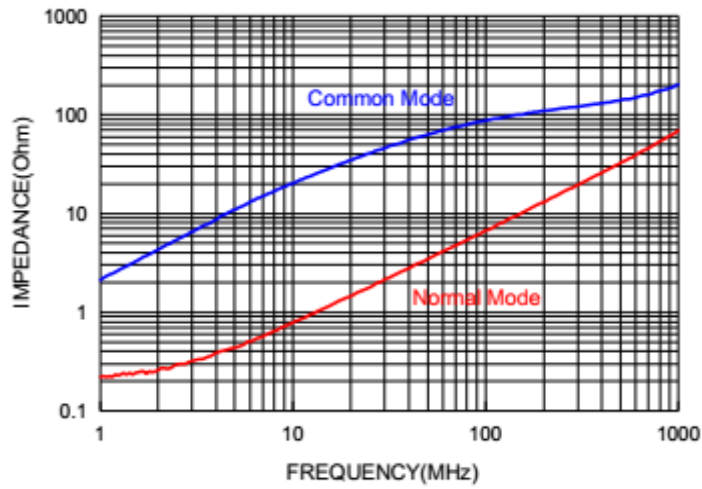

GCM-3225SF-601

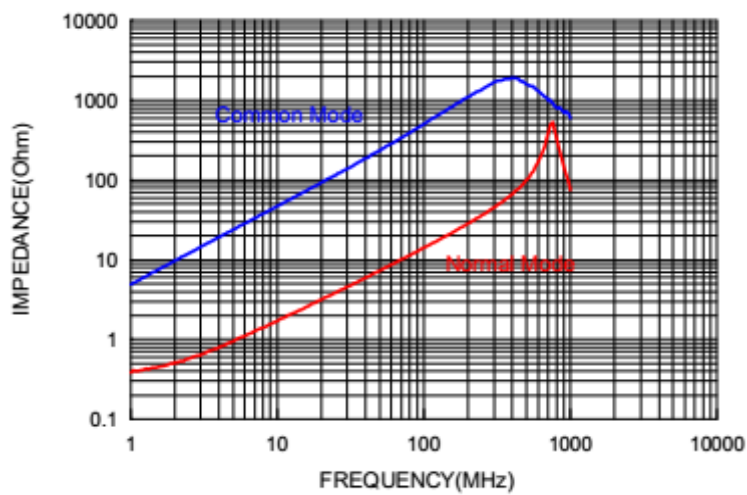

GCM-3225SF-102

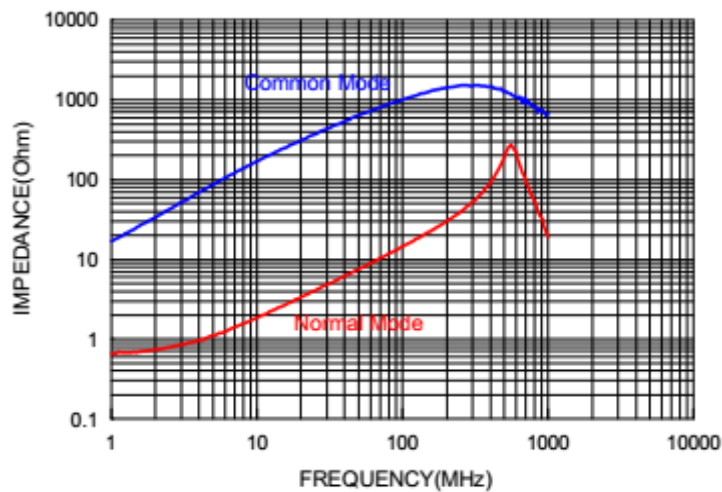

●可靠性测试/RELIABILITY TESTING

Operating Temperature	- 40 to +125 °C (Contain Heating coil)
Appearance Inspection	No external defects by visual inspection
Terminal Strength	After soldering , between copper plait and terminals of coils , push in two directions of X , Y with standing 10N(1.02kg) for10+/-2 sec. Terminal should not peel off. (Refer to figure at right)
Heat endurance of reflow soldering	Refer to figure
Insulating resistance	Over 100 MΩ at 100V D.C . between wire andcore
Dielectric Strength	Apply at 0.5KV 3mA for 1 minute between wire and core
Temperature characteristics	Inductance coefficient (0~2,000) × 10 / °C (- 40~ + 125 °C)
Humidity characteristics	Inductance deviation within ± 10% , after 96 hours in 90~95% relative humidity at 40 ± 2 °C and 1 hours drying under normal condition
A test is made under the above mentioned condition , and it is kept for 2 hours in the normal	

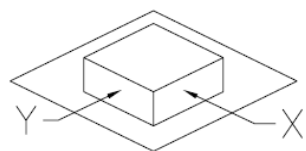

IR Reflow profile

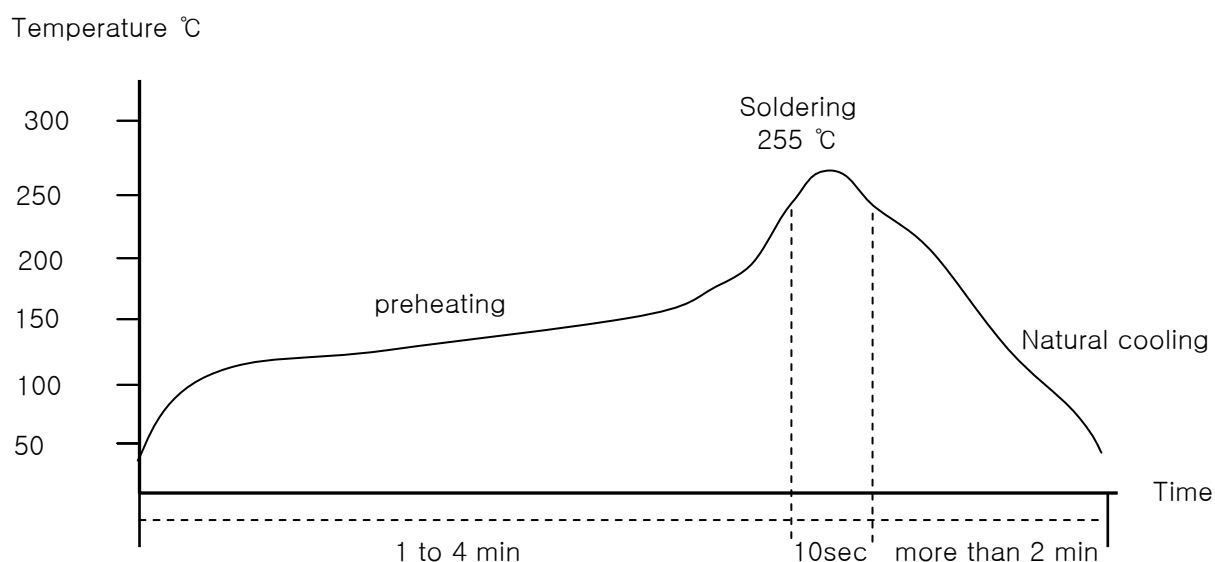

Temperature and humidity . After that , no mechanical and electrical defect should be found .

●材料清单/MATERIAL LIST

NO.	ITEM	DESCRIPTION
1	CORE	FERRITE
2	WIRE	P180 G1
3	ADHESIVE	5890LC
4	TIN	107H

●包装规格/PACKING SPECIFICATIONS

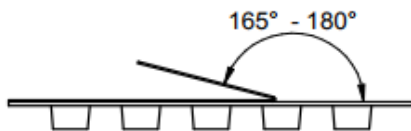
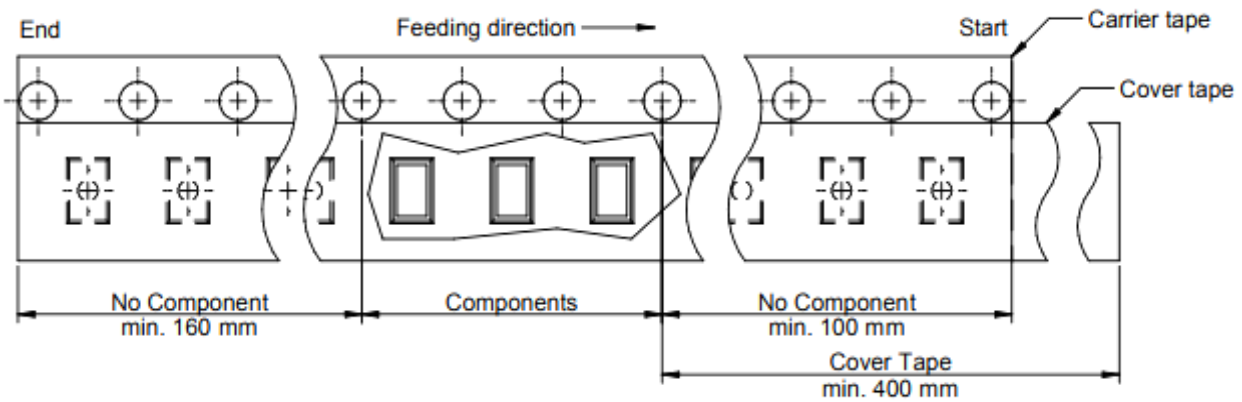

Tape width	Distance	Pull-of force
8 mm	4 mm	10~120g



轮盘：7'(直径178mm)
数量：2000PCS/盘

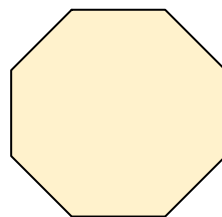

内盒/PE袋
数量：8000PCS/盒

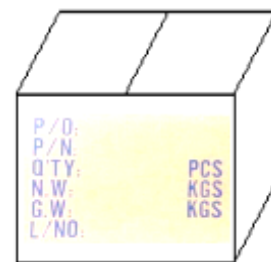

外箱，数量：80000PCS/箱
不足整箱用内盒或填充物装满